

SLEEK WIRING DEVICES TO ENHANCE YOUR SURROUNDINGS



HORIZON
A NOTCH ABOVE

Honeywell

HONEYWELL HORIZON SLEEK SLIM & STYLISH FOR EFFORTLESS ELEGANCE

An ideal space requires a harmonious blend of design that reflects your aesthetic preferences. Each color tone and shape has the power to elevate a design from the ordinary to extraordinary.

Honeywell Horizon enhances the aesthetic appeal of your surroundings by infusing a touch of class with its sleek curved design, slim profile and versatile color options.

Select Honeywell Horizon to create your masterpiece.



BEYOND THE ORDINARY

With its sleek 6mm plates, the Horizon range effortlessly blends into any wall, adding a touch of modernity to your space while ensuring easy installation. Elevate your surroundings with the perfect fusion of style and convenience.





A NOTCH ABOVE FOR MODERN HOMES

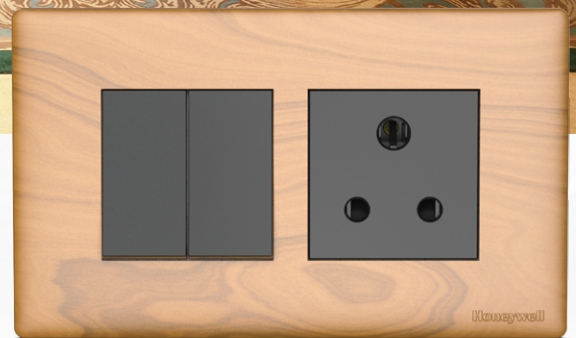

Elevate your home with the Horizon range, crafted from UV-stabilized engineered plastic. It is available in Glossy White, Jet Black, Magnesium Grey, Champagne Gold, Rose Gold, Sterling Silver and Red Oak Wood colors.



ISI-marked
Product Range



Unique Curved Switch Design
with Striking Colors



Fire
Retardant*



Shuttered Sockets
for Safety



Pencil-free Socket
Operations



RoHS Compliant for
Eco-friendliness

*Fire retardant material tested up to 960°C for GWT (Glow Wire Test)

A NOTCH ABOVE FOR CONTEMPORARY OFFICE SPACES

With the Horizon range, experience unmatched convenience and performance, ensuring seamless operations in modern workspaces. Crafted with a user-friendly design and reliable functionality, the Horizon range guarantees an uninterrupted experience.



Honeycomb Design
PC Grid Plate



IP20 Captive Screw
with Brass Terminals



Front Loading & Removal
of Wiring Devices



Module Rotation
for Flexibility



30W High Power Delivery
USB Type A+C Charger



Tested for 100k
Operations

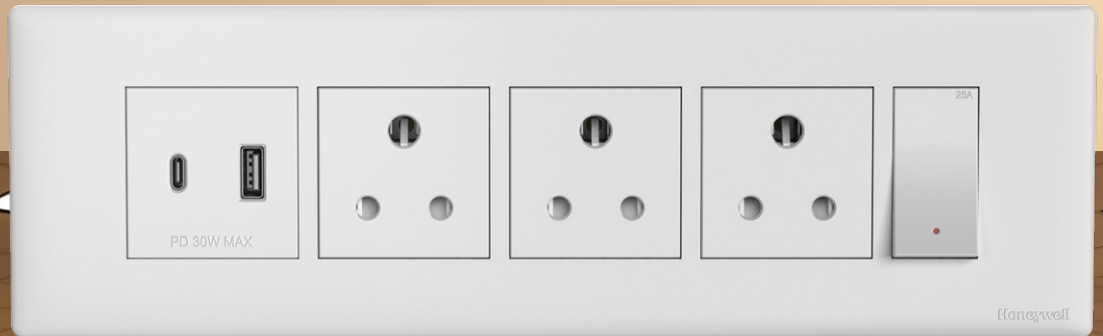



A NOTCH ABOVE IN DELIGHTFUL HOSPITALITY EXPERIENCE

Create a sophisticated and delightful hospitality experience with the Horizon range. It offers both style and durability with sleek rectangular plates and a unique curved design. The range is compatible with sublime touch switches, providing an enhanced user experience with feather-touch functionality.



BIS-approved
USB Charger



Unique Curved Switch Design
with Striking Colors



Soft Switches for
Enhanced Experiences**



Product Tested
at 250V AC



Anti-bacterial
Range*



Also Available with
Touch Switch

*This feature is only applicable for white color

**Operating Force: 2.5 N, Sound: 56db

AN AESTHETICAL GATEWAY TO INFINITE POSSIBILITIES

The Horizon range elevates your space with unparalleled aesthetic sophistication through its diverse colors. Each meticulously crafted product in the collection seamlessly blends with any interior, enhancing both functionality and style. The vibrant and elegant designs ensure that the Horizon range not only complements but also transforms your surroundings into a visually stunning space.



Jet Black

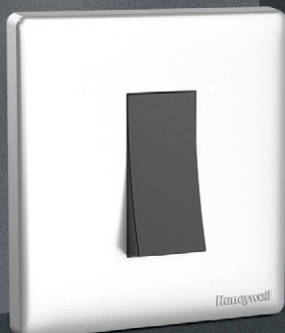

Sterling Silver



Glossy White



Magnesium Grey



Rose Gold



Champagne Gold



Red Oak Wood

Switches - White

Item Code	Description	Module	Carton Qty.
HW2501WHI	10AX One Way Switch	1M	30 / 450
HW2402WHI	10AX Two Way Switch	1M	30 / 450
HW2403WHI	10AX One Way with Indicator	1M	20 / 300
HW2601WHI	10AX Two Way Switch	2M	15 / 225
HW2411WHI	16AX One Way Switch	1M	30 / 450
HW2412WHI	16AX Two Way Switch	1M	30 / 450
HW2413WHI	16AX One Way with Indicator	1M	20 / 300
HW2220WHI	25A SP One Way Switch with Indicator	1M	20 / 300
HW2224WHI	32A DP Switch with Indicator	2M	15 / 225
HW2505WHI	6A Bell Push Switch	1M	30 / 450
HW2504WHI	6A Bell Push Switch with Indicator	2M	15 / 225
HW2506WHI	6A Bell Push Switch with Indicator	1M	20 / 300

Sockets - White

Item Code	Description	Module	Carton Qty.
HW2421WHI	6A Round Pin Socket (ISI Marked)	2M	20/300
HW2424WHI	6/16A Socket (ISI Marked)	2M	20/300

Fan Regulator, Buzzer & Dimmer - White

Item Code	Description	Module	Carton Qty.
HW2471WHI	100W Fan Step Controller (ISI Marked)	1M	20 / 300
HW2472WHI	120W Fan Step Controller (ISI Marked)	2M	15 / 225
HW2480WHI	400W Dimmer	2M	15 / 225
HW2485WHI	Electronic Buzzer	2M	15 / 225

Mini Trip MCB & Motor Starter - White

Item Code	Description	Module	Carton Qty
HW2217WHI	25A Motor Starter	2M	6 / 72
HW2227WHI	25A SP Mini Trip MCB	1M	12 / 144
HW2228WHI	25A DP Mini Trip MCB	2M	6 / 72

Communication Accessories - White

Item Code	Description	Module	Carton Qty.
HW2493WHI	RJ45 CAT 6A	1M	25 / 375
HW2491WHI	RJ45 Receptor	1M	25 / 375
HW2492WHI	RJ11 2 Line with Shutter	1M	30 / 450
HW2301WHI	HDMI Data transfer	1M	12 / 180



Support Accessories - White

Item Code	Description	Module	Carton Qty.
HW2441WHI	Blank Plate	1M	40 / 600
HW2451WHI	TV Coaxial Socket	1M	25 / 375
HW2462WHI	TV cable outlet	1M	25 / 375
HW2595WHI	Red Neon Indicator	1M	30 / 450
HW2586WHI	2.1A 1Port USB Charger	1M	25 / 375
HW2588WHI	18W 1Port C Type PD USB Charger	1M	25 / 375
HW2589WHI	2.1A 1Port C type USB Charger	1M	25 / 375
HW2590WHI	30W PD charger (Type A+C)	2M	15 / 225







Hospitality Accessories - White

Item Code	Description	Module	Carton Qty.
HW2414WHI	Two Way Switch with DND Mark	1M	20 / 300
HW2415WHI	One Way Switch with MMR Mark	1M	20 / 300
HW2903WHI	MML Indicator	1M	20 / 300
HW2416WHI	One Way Switch with MML Mark	1M	20 / 300
HW2507WHI	Bell Push with DND & MMR Indicator	2M	15 / 225
HW2529WHI	Shaver Socket	4M	1 / 6
HW2527WHI	Energy Key Tag with Time Delay	2M	4 / 60
HW2530WHI	LED Foot Lamp – Cool Day light	2M	15 / 225
HW2531WHI	LED Foot Lamp – Warm White light	2M	15 / 225

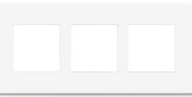

Front Plates - White

	Item Code	Description	Module	Carton Qty.
	HW2101WHI	1 Module Front Plate	1M	18 / 270
	HW2102WHI	2 Module Front Plate	2M	18 / 270
	HW2103WHI	3 Module Front Plate	3M	12 / 180
	HW2104WHI	4 Module Front Plate	4M	12 / 180
	HW2106WHI	6 Module Front Plate	6M	8 / 112
	HW218HWHI	8 Module Horizontal Front Plate	8M (H)	6 / 90
	HW218VWHI	8 Module Vertical Front Plate	8M (V)	4 / 64
	HW2109WHI	9 Module Front Plate	9M	6 / 90
	HW2112WHI	12 Module Front Plate	12M	4 / 56
	HW2116WHI	16 Module Front Plate	16M	4 / 48
	HW2118WHI	18 Module Front Plate	18M	3 / 21

Switches - Jet Black

	Item Code	Description	Module	Carton Qty.
	HW2401BLK	10AX One Way Switch	1M	30 / 450
	HW2402BLK	10AX Two Way Switch	1M	30 / 450
	HW2403BLK	10AX One Way with Indicator	1M	20 / 300
	HW2601BLK	10AX Two Way Switch	2M	15/225
	HW2411BLK	16AX One Way Switch	1M	30 / 450
	HW2412BLK	16AX Two Way Switch	1M	30 / 450
	HW2413BLK	16AX One Way with Indicator	1M	20 / 300
	HW2220BLK	25A SP One Way Switch with Indicator	1M	20 / 300
	HW2224BLK	32A DP Switch with Indicator	2M	15 / 225
	HW2505BLK	6A Bell Push Switch	1M	30 / 450
	HW2504BLK	6A Bell Push Switch with Indicator	2M	15 / 225

Sockets - Jet Black

 HW2424BLK	Item Code	Description	Module	Carton Qty.
	HW2421BLK	6A Round Pin Socket (ISI Marked)	2M	20/300
	HW2424BLK	6/16A Socket (ISI Marked)	2M	20/300

Fan Regulator & Buzzer - Jet Black

 HW2471BLK HW2472BLK	Item Code	Description	Module	Carton Qty.
	HW2471BLK	100W Fan Step Controller (ISI Marked)	1M	20 / 300
	HW2472BLK	120W Fan Step Controller (ISI Marked)	2M	15 / 225
	HW2485BLK	Electronic Buzzer	2M	15 / 225

Mini Trip MCB & Motor Starter - Jet Black

	Item Code	Description	Module	Carton Qty.
	HW2217BLK	25A Motor Starter	2M	6 / 72
	HW2227BLK	25A SP Mini Trip MCB	1M	12 / 144

Communication Accessories - Jet Black

	Item Code	Description	Module	Carton Qty.
	HW2493BLK	RJ45 CAT 6A	1M	25 / 375
	HW2492BLK	RJ11 2 Line with Shutter	1M	30 / 450
	HW2301BLK	HDMI Data transfer	1M	12 / 180

Support Accessories - Jet Black

 HW2586BLK	Item Code	Description	Module	Carton Qty.
	HW2441BLK	Blank Plate	1M	40 / 600
	HW2451BLK	TV Coaxial Socket	1M	25 / 375
	HW2586BLK	2.1A 1Port USB Charger	1M	25 / 375
	HW2588BLK	18W 1Port C Type PD USB Charger	1M	25 / 375
	HW2589BLK	2.1A 1Port C type USB Charger	1M	25 / 375
	HW2590BLK	30W PD charger (Type A+C)	2M	15 / 225

Hospitality Accessories - Jet Black



HW2527BLK



HW2414BLK



HW2415BLK

Item Code	Description	Module	Carton Qty.
HW2414BLK	Two Way Switch with DND Mark	1M	20 / 300
HW2415BLK	One Way Switch with MMR Mark	1M	20 / 300
HW2903BLK	MML Indicator	1M	20 / 300
HW2416BLK	One Way Switch with MML Mark	1M	20 / 300
HW2507BLK	Bell Push with DND & MMR Indicator	2M	15 / 225
HW2529BLK	Shaver Socket	4M	1 / 6
HW2527BLK	Energy Key Tag with Time Delay	2M	4 / 60
HW2530BLK	LED Foot Lamp – Cool Day light	2M	15 / 225
HW2531BLK	LED Foot Lamp – Warm White light	2M	15 / 225

Front Plates - Jet Black



HW2101BLK



HW2103BLK





HW2104BLK



HW2105BLK

Item Code	Description	Module	Carton Qty.
HW2101BLK	1 Module Front Plate	1M	18 / 270
HW2102BLK	2 Module Front Plate	2M	18 / 270
HW2103BLK	3 Module Front Plate	3M	12 / 180
HW2104BLK	4 Module Front Plate	4M	12 / 180
HW2106BLK	6 Module Front Plate	6M	8 / 112
HW218HBLK	8 Module Horizontal Front Plate	8M (H)	6 / 90
HW218VBLK	8 Module Vertical Front Plate	8M (V)	4 / 64
HW2109BLK	9 Module Front Plate	9M	6 / 90
HW2112BLK	12 Module Front Plate	12M	4 / 56
HW2116BLK	16 Module Front Plate	16M	4 / 48
HW2118BLK	18 Module Front Plate	18M	3 / 21

Switches - Magnesium Grey

	Item Code	Description	Module	Carton Qty.
 HW2501GRY	HW2401GRY	10AX One Way Switch	1M	30 / 450
	HW2402GRY	10AX Two Way Switch	1M	30 / 450
	HW2403GRY	10AX One Way with Indicator	1M	20 / 300
	HW2601GRY	10AX Two Way Switch	2M	15 / 225
 HW2502GRY	HW2411GRY	16AX One Way Switch	1M	30/450
	HW2412GRY	16AX Two Way Switch	1M	30/450
 HW2413GRY	HW2413GRY	16AX One Way with Indicator	1M	20/300
	HW2220GRY	25A SP One Way Switch with Indicator	1M	20 / 300
 HW2224GRY	HW2224GRY	32A DP Switch with Indicator	2M	15/225
	HW2505GRY	6A Bell Push Switch	1M	30 / 450
	HW2504GRY	6A Bell Push Switch with Indicator	2M	15/225

Sockets - Magnesium Grey

	Item Code	Description	Module	Carton Qty.
 HW2424GRY	HW2421GRY	6A Round Pin Socket (ISI Marked)	2M	20/300
	HW2424GRY	6/16A Socket (ISI Marked)	2M	20/300

Fan Regulator & Buzzer - Magnesium Grey

	Item Code	Description	Module	Carton Qty.
 HW2471GRY	HW2471GRY	100W Fan Step Controller (ISI Marked)	1M	20 / 300
	HW2472GRY	120W Fan Step Controller (ISI Marked)	2M	15 / 225
	HW2485GRY	Electronic Buzzer	2M	15 / 225

Mini Trip MCB & Motor Starter - Magnesium Grey

	Item Code	Description	Module	Carton Qty.
 HW2217GRY	HW2217GRY	25A Motor Starter	2M	6 / 72
	HW2227GRY	25A SP Mini Trip MCB	1M	12 / 144

Communication Accessories - Magnesium Grey

Item Code	Description	Module	Carton Qty.
HW2493GRY	RJ45 CAT 6A	1M	25 / 375
HW2492GRY	RJ11 2 Line with Shutter	1M	30 / 450
HW2301GRY	HDMI Data transfer	1M	12 / 180

Support Accessories - Magnesium Grey

Item Code	Description	Module	Carton Qty.
HW2441GRY	Blank Plate	1M	40 / 600
HW2451GRY	TV Coaxial Socket	1M	25 / 375
HW2586GRY	2.1A 1Port USB Charger	1M	25 / 375
HW2588GRY	18W 1 Port C Type PD USB Charger	1M	25 / 375
HW2589GRY	2.1A 1Port C type USB Charger	1M	25 / 375
HW2590GRY	30W PD charger (Type A+C)	2M	15 / 225



HW2441GRY



HW2451GRY

Hospitality Accessories - Magnesium Grey

Item Code	Description	Module	Carton Qty.
HW2414GRY	Two Way Switch with DND Mark	1M	20 / 300
HW2415GRY	One Way Switch with MMR Mark	1M	20 / 300
HW2903GRY	MML Indicator	1M	20 / 300
HW2416GRY	One Way Switch with MML Mark	1M	30 / 450
HW2507GRY	Bell Push with DND & MMR Indicator	2M	15 / 225
HW2529GRY	Shaver Socket	4M	1 / 6
HW2527GRY	Energy Key Tag with Time Delay	2M	4 / 60
HW2530GRY	LED Foot Lamp – Cool Day light	2M	15 / 225
HW2531GRY	LED Foot Lamp – Warm White light	2M	15 / 225



HW2507GRY



HW2414GRY



HW2902GRY

Front Plates - Magnesium Grey

Item Code	Description	Module	Carton Qty.
HW2101GRY	1 Module Front Plate	1M	18 / 270
HW2102GRY	2 Module Front Plate	2M	18 / 270
HW2103GRY	3 Module Front Plate	3M	12 / 180
HW2104GRY	4 Module Front Plate	4M	12 / 180
HW2106GRY	6 Module Front Plate	6M	8 / 112
HW218HGRY	8 Module Horizontal Front Plate	8M (H)	6 / 90
HW218VGRY	8 Module Vertical Front Plate	8M (V)	4 / 64
HW2109GRY	9 Module Front Plate	9M	6 / 90
HW2112GRY	12 Module Front Plate	12M	4 / 56
HW2116GRY	16 Module Front Plate	16M	4 / 48
HW2118GRY	18 Module Front Plate	18M	3 / 21



HW2101GRY



HW2106GRY

Front Plates - Sterling Silver

Item Code	Description	Module	Carton Qty.
HW2101SLV	1 Module Front Plate	1M	18 / 270
HW2102SLV	2 Module Front Plate	2M	18 / 270
HW2103SLV	3 Module Front Plate	3M	12 / 180
HW2104SLV	4 Module Front Plate	4M	12 / 180
HW2106SLV	6 Module Front Plate	6M	8 / 112
HW218HSLV	8 Module Horizontal Front Plate	8M (H)	6 / 90
HW218VSLV	8 Module Vertical Front Plate	8M (V)	4 / 64
HW2109SLV	9 Module Front Plate	9M	6 / 90
HW2112SLV	12 Module Front Plate	12M	4 / 56
HW2116SLV	16 Module Front Plate	16M	4 / 48
HW2118SLV	18 Module Front Plate	18M	3 / 21













HW2101SLV













HW2103SLV

Front Plates - Champagne Gold

	Item Code	Description	Module	Carton Qty.
	HW2101GLD	1 Module Front Plate	1M	18 / 270
HW2101GLD	HW2102GLD	2 Module Front Plate	2M	18 / 270
	HW2102GLD	2 Module Front Plate	2M	18 / 270
HW2102GLD	HW2103GLD	3 Module Front Plate	3M	12 / 180
	HW2103GLD	3 Module Front Plate	3M	12 / 180
HW2103GLD	HW2104GLD	4 Module Front Plate	4M	12 / 180
	HW2104GLD	4 Module Front Plate	4M	12 / 180
HW2104GLD	HW2106GLD	6 Module Front Plate	6M	8 / 112
	HW2106GLD	6 Module Front Plate	6M	8 / 112
HW2106GLD	HW218HGLD	8 Module Horizontal Front Plate	8M (H)	6 / 90
	HW218HGLD	8 Module Horizontal Front Plate	8M (H)	6 / 90
HW218HGLD	HW218VGLD	8 Module Vertical Front Plate	8M (V)	4 / 64
	HW218VGLD	8 Module Vertical Front Plate	8M (V)	4 / 64
HW218VGLD	HW2109GLD	9 Module Front Plate	9M	6 / 90
	HW2109GLD	9 Module Front Plate	9M	6 / 90
HW2109GLD	HW2112GLD	12 Module Front Plate	12M	4 / 56
	HW2112GLD	12 Module Front Plate	12M	4 / 56
HW2112GLD	HW2116GLD	16 Module Front Plate	16M	4 / 48
	HW2116GLD	16 Module Front Plate	16M	4 / 48
HW2116GLD	HW2118GLD	18 Module Front Plate	18M	3 / 21
	HW2118GLD	18 Module Front Plate	18M	3 / 21

Front Plates - Rose Gold

	Item Code	Description	Module	Carton Qty.
	HW2101RGL	1 Module Front Plate	1M	18 / 270
HW2101RGL	HW2102RGL	2 Module Front Plate	2M	18 / 270
	HW2102RGL	2 Module Front Plate	2M	18 / 270
HW2102RGL	HW2103RGL	3 Module Front Plate	3M	12 / 180
	HW2103RGL	3 Module Front Plate	3M	12 / 180
HW2103RGL	HW2104RGL	4 Module Front Plate	4M	12 / 180
	HW2104RGL	4 Module Front Plate	4M	12 / 180
HW2104RGL	HW2106RGL	6 Module Front Plate	6M	8 / 112
	HW2106RGL	6 Module Front Plate	6M	8 / 112
HW2106RGL	HW218HRGL	8 Module Horizontal Front Plate	8M (H)	6 / 90
	HW218HRGL	8 Module Horizontal Front Plate	8M (H)	6 / 90
HW218HRGL	HW218VRGL	8 Module Vertical Front Plate	8M (V)	4 / 64
	HW218VRGL	8 Module Vertical Front Plate	8M (V)	4 / 64
HW218VRGL	HW2109RGL	9 Module Front Plate	9M	6 / 90
	HW2109RGL	9 Module Front Plate	9M	6 / 90
HW2109RGL	HW2112RGL	12 Module Front Plate	12M	4 / 56
	HW2112RGL	12 Module Front Plate	12M	4 / 56
HW2112RGL	HW2116RGL	16 Module Front Plate	16M	4 / 48
	HW2116RGL	16 Module Front Plate	16M	4 / 48
HW2116RGL	HW2118RGL	18 Module Front Plate	18M	3 / 21
	HW2118RGL	18 Module Front Plate	18M	3 / 21

Front Plates - Red Oak Wood



HW2101WDD

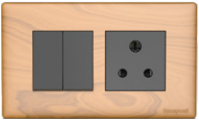

HW2104WDD

Item Code	Description	Module	Carton Qty.
HW2101WDD	1 Module Front Plate	1M	18 / 270
HW2102WDD	2 Module Front Plate	2M	18 / 270
HW2103WDD	3 Module Front Plate	3M	12 / 180
HW2104WDD	4 Module Front Plate	4M	12 / 180
HW2106WDD	6 Module Front Plate	6M	8 / 112
HW218HWDD	8 Module Horizontal Front Plate	8M (H)	6 / 90
HW218VWDD	8 Module Vertical Front Plate	8M (V)	4 / 64
HW2109WDD	9 Module Front Plate	9M	6 / 90
HW2112WDD	12 Module Front Plate	12M	4 / 56
HW2116WDD	16 Module Front Plate	16M	4 / 48
HW2118WDD	18 Module Front Plate	18M	3 / 21

Front Plates

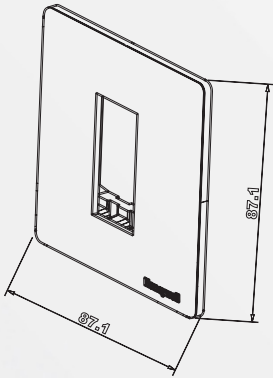

1M

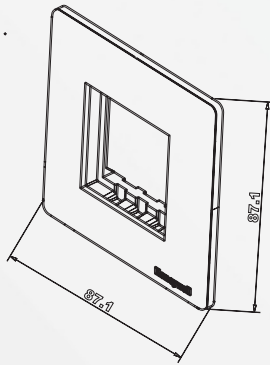

2M

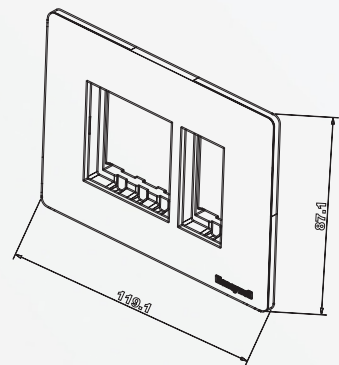

3M

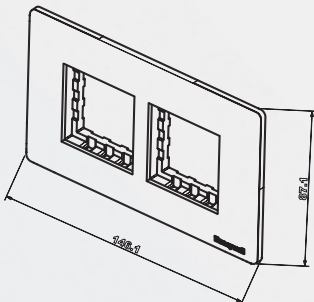

4M

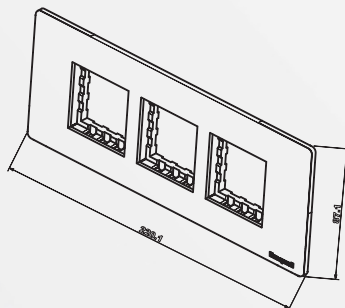

6M

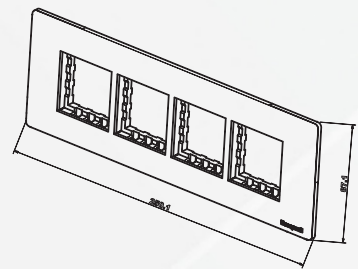

8M (H)

All dimensions are in mm.

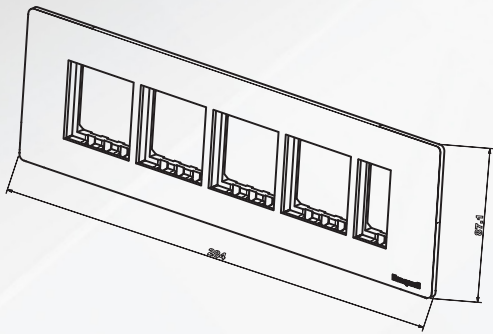

9M

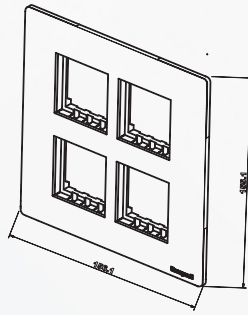

8M (S)

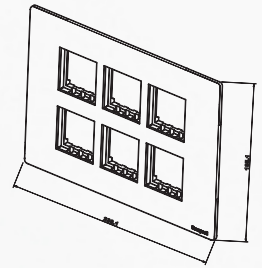

12M

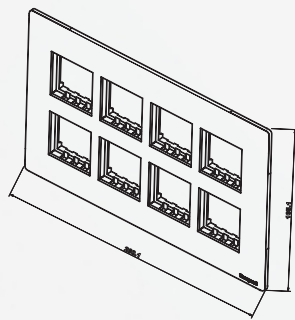

16M

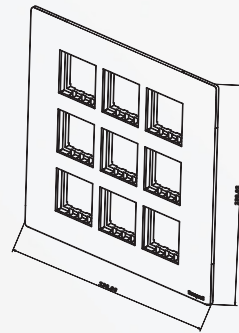

18M

All dimensions are in mm.

Metal Boxes - Dimensions

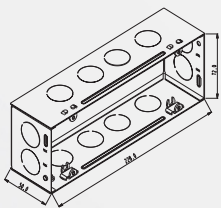

1M & 2M

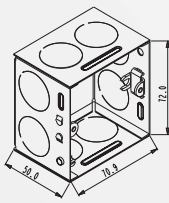

3M

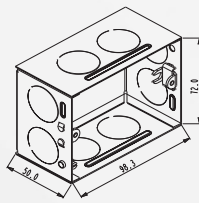

4M

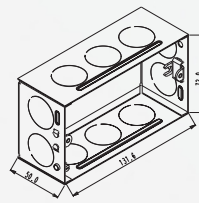

6M

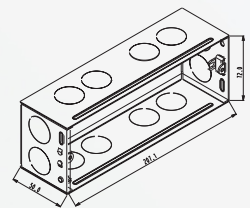

8M (H)

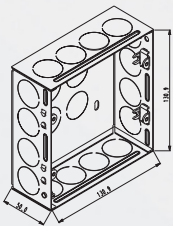

8M (S)

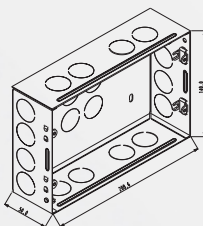

12M

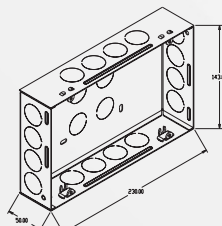

16M

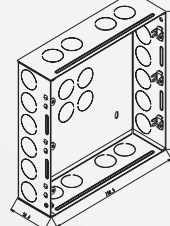

18M

All dimensions are in mm.

Plastic Surface Boxes - Dimensions

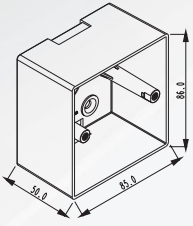

1M & 2M

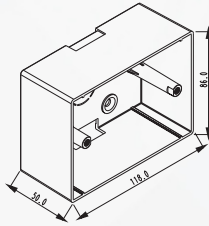

3M

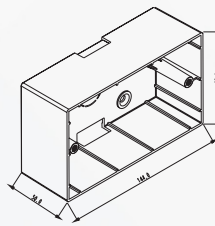

4M

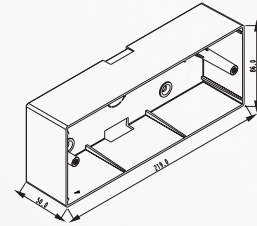

6M

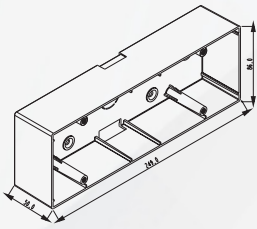

8M (S)

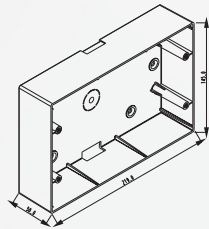

12M

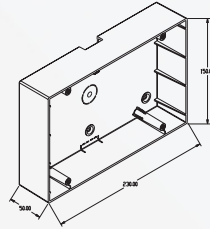

16M

All dimensions are in mm.

Designed to Deliver on Certified Industry Standards



BIS-approved
USB Charger



RoHS
Compliant Range



ISI-marked Switches, Sockets
and Fan Speed Controllers

BARODA

Ground Floor, 1965,
Alembic City Avenue,
Alembic Campus, Alembic Road,
Baroda - 390 003

BENGALURU

Honeywell Camp II,
Bldgs 9A & 9B, Plot C2, RMZ Ecoworld,
Varturhobli, Sarjapur Marathahalli,
Outer Ring Road,
Bengaluru - 560 103

CHENNAI

5th, 6th & 7th Floor,
KRM Plaza, North Tower,
#2, Harrington Road, Chetpet,
Chennai - 600 031

GURUGRAM

Unitech Trade Center,
5th Floor, Sector 43, Block C,
Sushant Lok, Phase 1,
Gurugram - 122 022

HYDERABAD

8-2-418, Krishnama House,
3rd Floor, Road No. 7,
Banjara Hills,
Hyderabad - 500 034

KOLKATA

Srijan Techpark,
8th Floor, DN-52,
Salt Lake, Sector-V,
Kolkata - 700 091

MUMBAI

WeWork Chromium,
6th Floor, Milind Nagar,
Opp. L&T Flyover, JVLR, Powai,
Mumbai - 400 076

PUNE

Plot No. 56/57,
Hadapsar Industrial Estate,
Pune - 411 013

Note: Continuous enhancements in product design and development may result in variations.
Actual product and color may vary due to printing limitations.

**FOR FURTHER DETAILS,
PLEASE REACH US AT :**

Toll Free Number : 1800-103-3848
Monday to Sunday : 10AM - 7PM
Whatsapp : +91 81306-91299
Email : BuildingAutomation.BMSIndia@honeywell.com
Website: www.honeywellbuildings.in